



KONFERENCIJA “DRVO U GRADITELJSTVU”



8. veljače 2022.



10:30



hotel Ambassador, Opatija



REPUBLIKA HRVATSKA
Ministarstvo prostornoga uređenja,
graditeljstva i državne imovine



HUP
Hrvatsko udruženje profesionalaca

oris
KUĆArhitekture
HOUSE OF ARCHITECTURE





**Doprinos Fakulteta razvoju novih proizvoda od
drva za graditeljstvo kao ključnom elementu
niskougljične strategije Europskog zelenog plana**

izv.prof.dr.sc. Vjekoslav Živković
prodekan Drvnotehnološkog odsjeka



KONFERENCIJA
“DRVO U GRADITELJSTVU”

O fakultetu



KONFERENCIJA “DRVO U GRADITELJSTVU”

Fakultet šumarstva i drvene tehnologije

➤ Šumarski odsjek

➤ Drvnotehnološki odsjek

~200 zaposlenih

~ 100 nastavnika (doc. – prof.)

< 10 asistenata i poslijedoktoranada

~ 25 zaposlenih na projektima

→ 14 na DTO



KONFERENCIJA
“DRVO U GRADITELJSTVU”

LDG laboratorij





U GRA



Potvrda o akreditaciji Accreditation Certificate

Ovime se utvrđuje da je
This is to recognize that

Sveučilište u Zagrebu Šumarski fakultet
Zavod za namještaj i drvene proizvode
Laboratorij za drvo u graditeljstvu
Svetošimunska cesta 25, HR-10000 Zagreb

osposobljen prema zahtjevima norme
is competent according to
HRN EN ISO/IEC 17025:2007
(ISO/IEC 17025:2005+Cor.1:2006
EN ISO/IEC 17025:2005+AC:2006)
za
to carry out

Ispitivanje drvenih podnih obloga, površinske obrade drvenih
podova, ljepljiva za drvene podove i odabranih fizikalnih
svojstava drva
Testing wood flooring, finishes for wood flooring, adhesives for wood
flooring and selected physical wood properties

br./no: 1175/09
Klasa: 383-03/08-30/27
Ubroj: 589-03/5-09-15
Zagreb, 2009-03-25

Datum isteka-Expiry date: 2014-03-24
Prva akreditacija-First accreditation: /
Stranice priloga-Annex pages: 4

Ravnateljica:
Director General:
Mr. sc. Biserka Bajzek Brezak, dipl. ing.

 HAA Hrvatska akreditacijska agencija
Croatian Accreditation Agency

HAA-Ob-777-1-Isdaje 2

Laboratorij za drvo u graditeljstvu



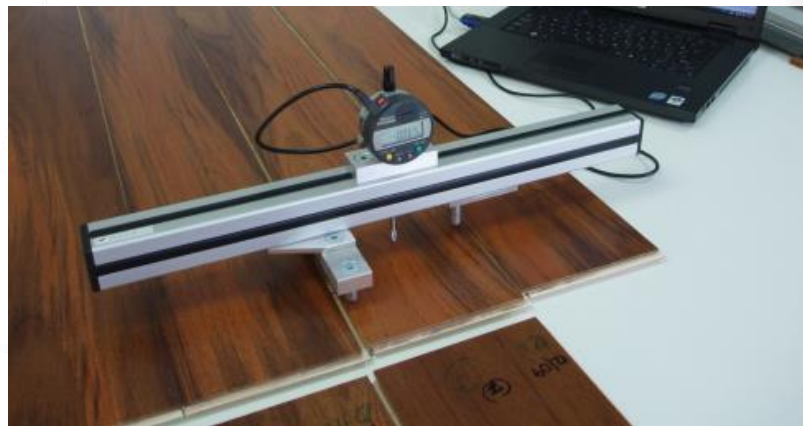

KONFERENCIJA "DRVO U GRADITELJSTVU"

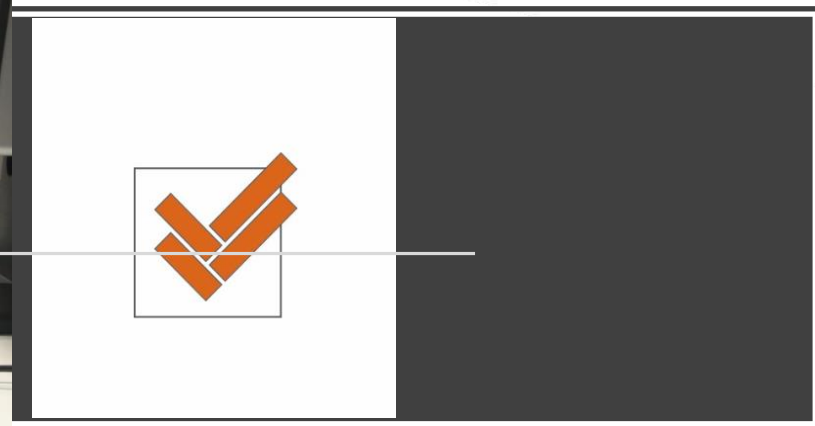
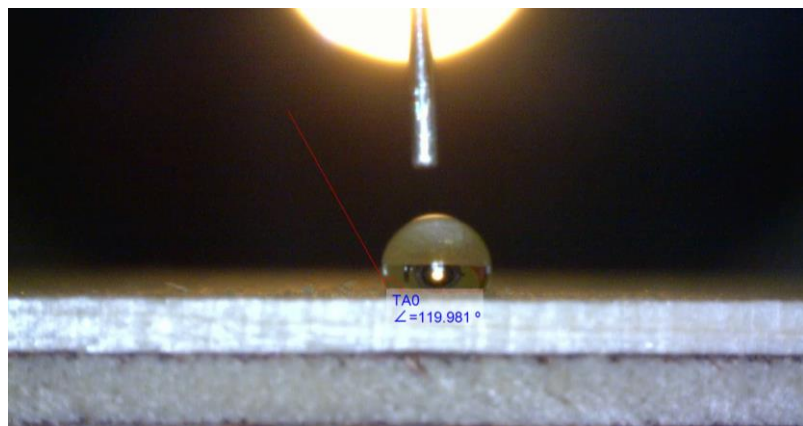
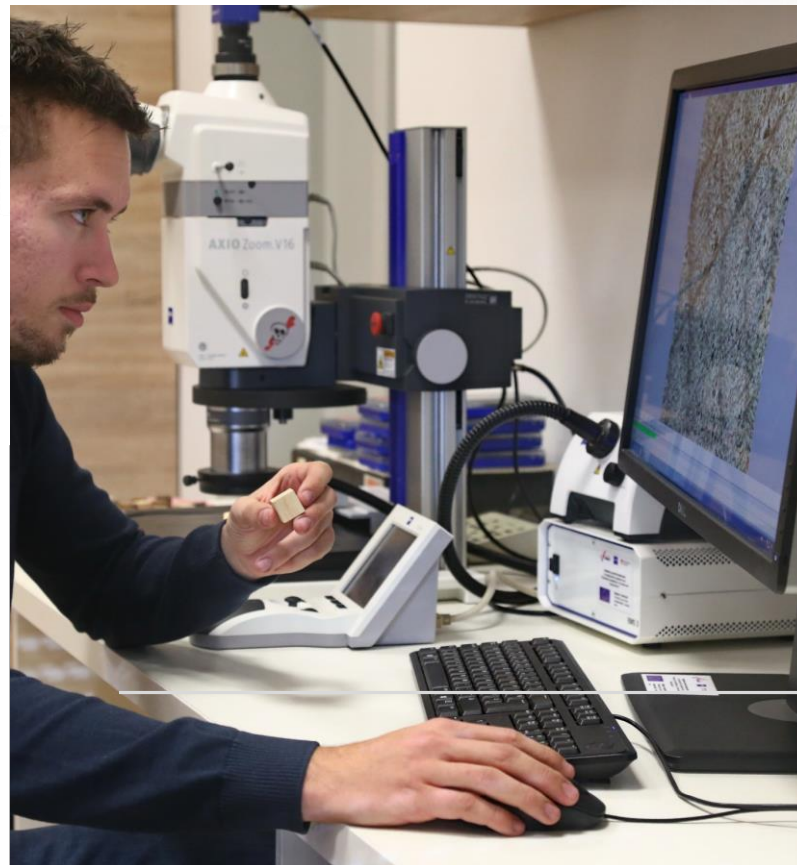
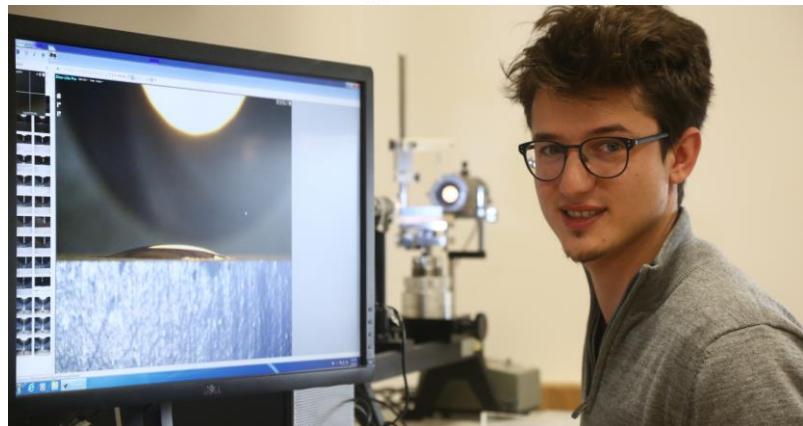

A close-up photograph of a person's hands using a hand plane to smooth a piece of wood on a workbench. The wood is being held steady by one hand while the other hand guides the plane. The background is slightly blurred, showing a workshop environment.

KONFERENCIJA
“DRVO U GRADITELJSTVU”

Zašto je korišćenje drva u
gradnji važna tema?

Korištenje DuG...

KONFERENCIJA
“DRVO U GRADITELJSTVU”

Strategija EU za šume do 2030.

- ...**smanjenje emisija**...za 55%
- ...smanjenje emisija s pomoću prirodnih ponora (**pošumljavanje**)
- ...održanje radnih mjesta u ruralnim područjima
- ...**kaskadna uporaba drva**
- ...održivo proizvedeni i **dugovječni drvni proizvodi** – spremnik ugljika i supstitucijska ušteda
- ...prijava promjene zaliha ugljika u šumama i spremnicima (**proizvodi od drva**)

Europski zeleni plan

- **Modernizacija gospodarstva** u cilju klimatske neutralnosti do 2050.
- Prelazak na **čistu energiju**
- Potpora **kružnom dizajnu** svih proizvoda → **ponovna uporaba** materijala prije recikliranja je prioritet
- Val **energetske obnove**
- **Pošumljavanje**
- Promicanje tranzicije na **niskougljične aktivnosti**
- Istraživanja koja **povezuju društvene potrebe i tehnološki napredak**

Strategija EU za šume do 2030.

- ...**podupirati DPI** u prilagodbi na promjenjive i raznolike šumske resurse
- ...**usmjeriti ulaganja na proizvodnju dugovječnih proizvoda od drva iz trupaca niže kvalitete**
- ...boriti se protiv zabluda o riziku od požara i manjoj trajnosti drvnih proizvoda

Novi europski Bauhaus

- ...intenzivirati istraživanja, inovacije i projektiranje proizvoda od drva
- ...povećati kaskadnu upotrebu drva i povećati kružnost

Inovacijski fond EU

- ...potpore za inovativne građevinske projekte uklj. **drvnu gradnju**

A close-up photograph of a person's hands using a hand plane to smooth a piece of wood on a workbench. The wood is being held steady by one hand while the other hand guides the plane. The background is slightly blurred, showing a workshop setting with various tools and materials.

KONFERENCIJA
“DRVO U GRADITELJSTVU”

Stanje na tržištu

Građevni proizvodi

KONFERENCIJA “DRVO U GRADITELJSTVU”

proizvodnja LLD u 2020.	ukupno (mio m ³ /god.)	mogući broj zgrada
Austrija	1.59	7.373
Njemačka	1.32	6.121



proizv. CLT	svijet (mio m ³)
2020.	2
2025.	4

CLT u 2020.	(%)	mogući br. kuća
Europa	48	10.500
Sj. Amerika	43	9.500

Građevni proizvodi

KONFERENCIJA “DRVO U GRADITELJSTVU”

Montažne kuće

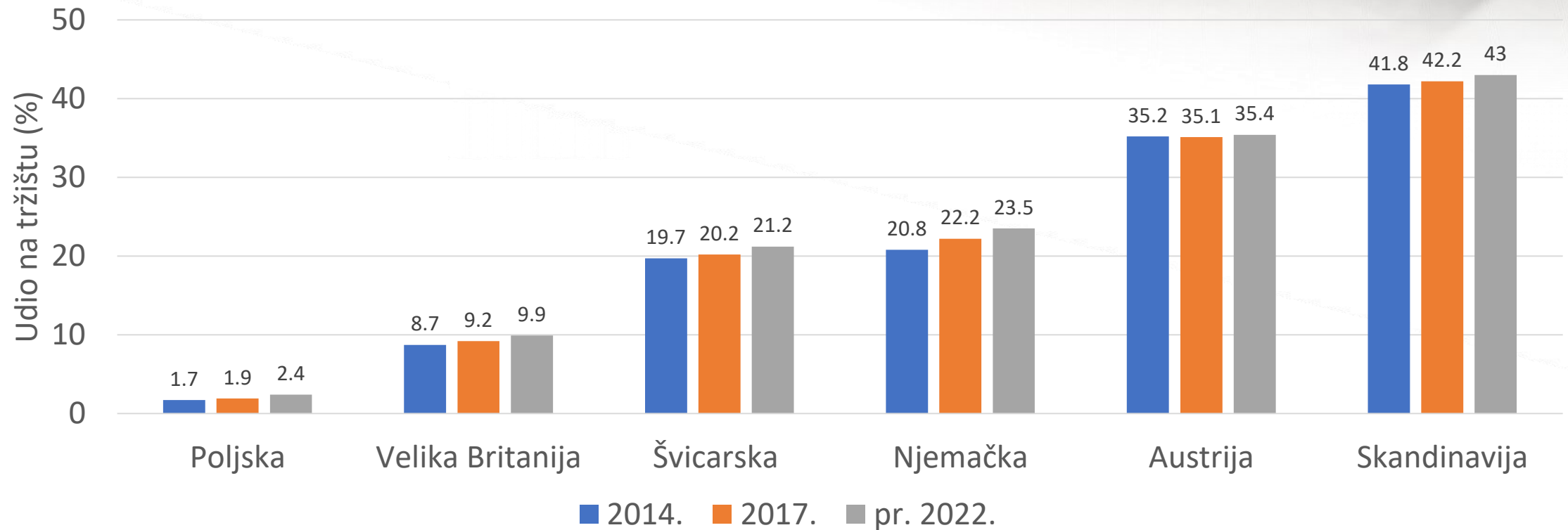

MATERIJALI za prozore - udio na tržištu (2014.)

KONFERENCIJA “DRVO U GRADITELJSTVU”

Drvo

Drvo – aluminij

PVC

Aluminij



Kako povećati uporabu DuG

- Promidžba DuG
- Edukacija projektanata i krajnjih korisnika
- Poticaji krajnjim korisnicima
- Razvoj novih materijala
- Razvoj novih proizvoda



KONFERENCIJA
“DRVO U GRADITELJSTVU”

Engineered Wood Market - Growth Rate by Region, 2021-2026



Source: Mordor Intelligence



KONFERENCIJA
“DRVO U GRADITELJSTVU”

Što fakultet čini?



Poziv: Povećanje razvoja novih proizvoda i usluga koji proizlaze iz aktivnosti istraživanja i razvoja (IRI 1 i 2)



Projekti	
1	Istraživanje u poduzeću Spačva d.d. u svrhu razvoja inovativnih masivnih vrata od slavonske hrastovine (prijavitelj: Spačva d.d.) vrijednost: 30,37 mio kn , bespovratno: 20,72 mio kn
2	Istraživanje i razvoj inovativnih drvnih zidnih obloga, pregradnih i nosivih zidova za održivu gradnju u poduzeću Spačva d.d., vrijednost: 46,15 mio kn , bespovratno 29,94 mio kn
3	Razvoj inovativnih proizvoda iz modificirane slavonske hrastovine (Prijavitelj: Spin valis d.o.o.) vrijednost: 55,06 mio kn , bespovratno 23,94 mio kn
4	Razvoj inovativne tehničko-tehnološke linije za proizvodnju naprednih bioadhesiva na bazi utekućenog drva – LiqWOODTech (prijavitelj Eksid d.o.o.) vrijednost: 24,05 mio kn , bespovratno: 10,32 mio kn
5	Razvoj inovativnih peleta iz šumske i/ili poljoprivredne biomase - INOPELET (prijavitelj: Bjelin Otok d.o.o.) vrijednost: 46,4 mio kn , bespovratno 28,28 mio kn



HRZZ

Hrvatska zaklada
za znanost

InnoCOAT – inovativna tehnologija
površinske obrade drvnih ploča

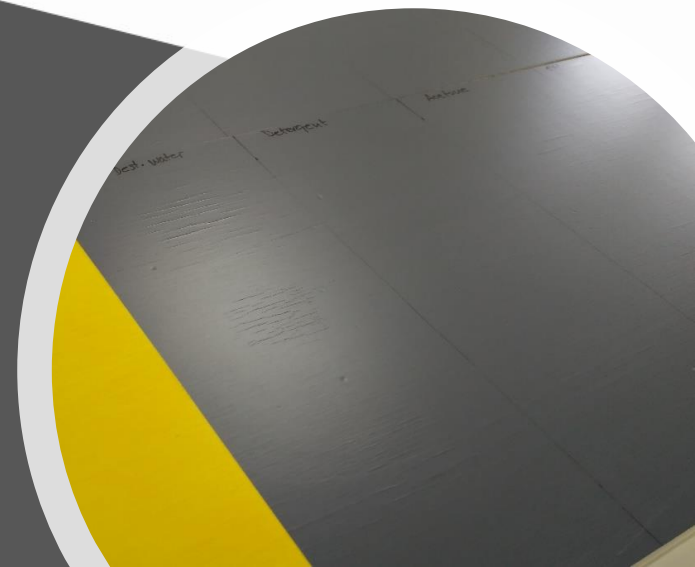
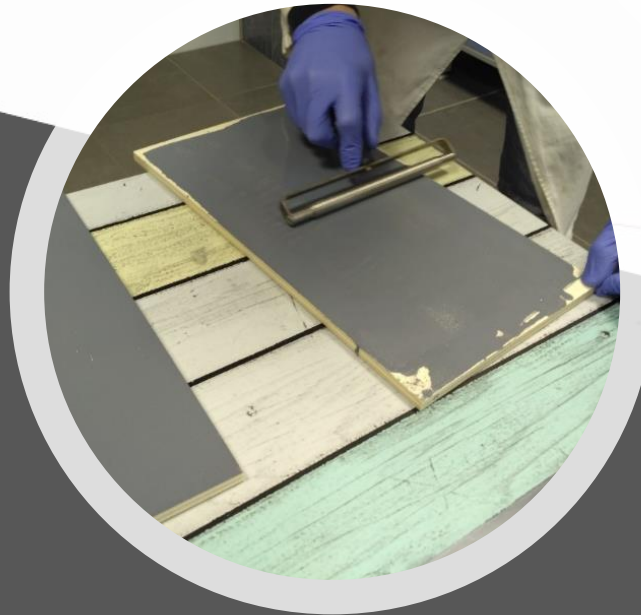

*Projekt sa stranim
industrijskim partnerom*



*Istraživanje u
suradnji s tvrtkom*



Operativni program
**KONKURENTNOST
I KOHEZIJA**



Europska unija
Zajedno do fondova EU



EUROPSKI STRUKTURNI
I INVESTICIJSKI FONDOVI

KONFERENCIJA “DRVO U GRADITELJSTVU”

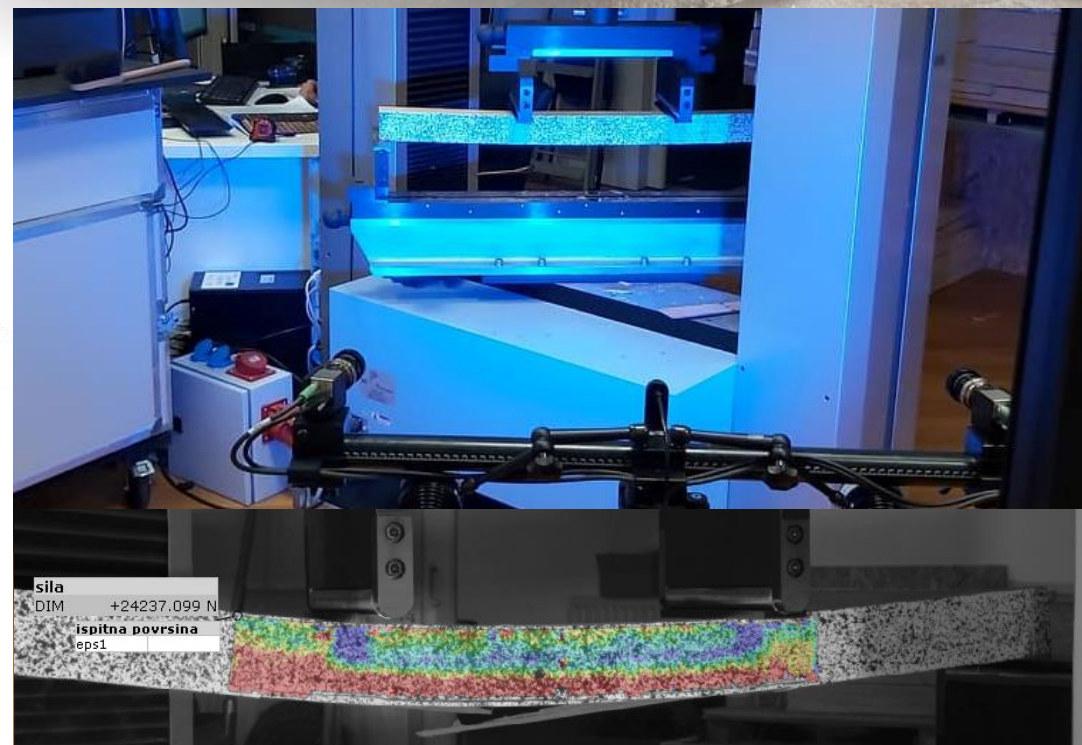

FERIT

Razvoj novih i unaprjeđenje
funkcionalnosti postojećih
hrastovih ulaznih vrata

Razvoj hrastovih zidnih obloga i zidova za održivu gradnju

KONFERENCIJA “DRVO U GRADITELJSTVU”

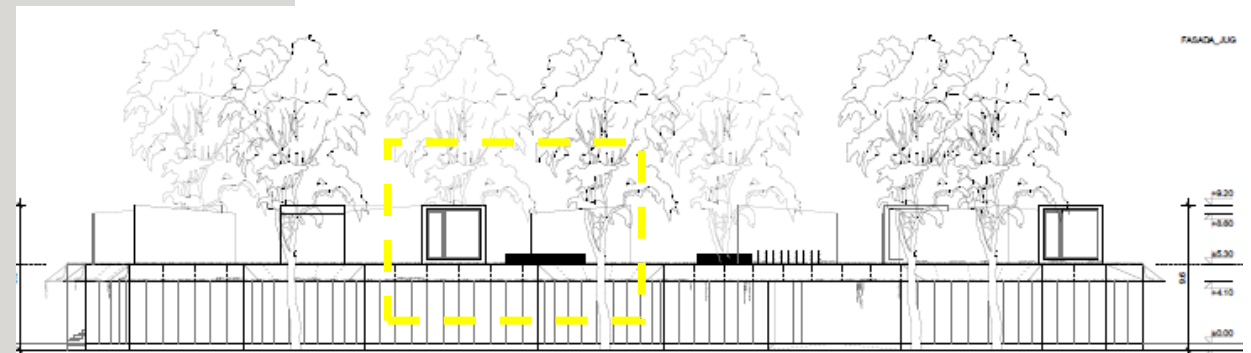
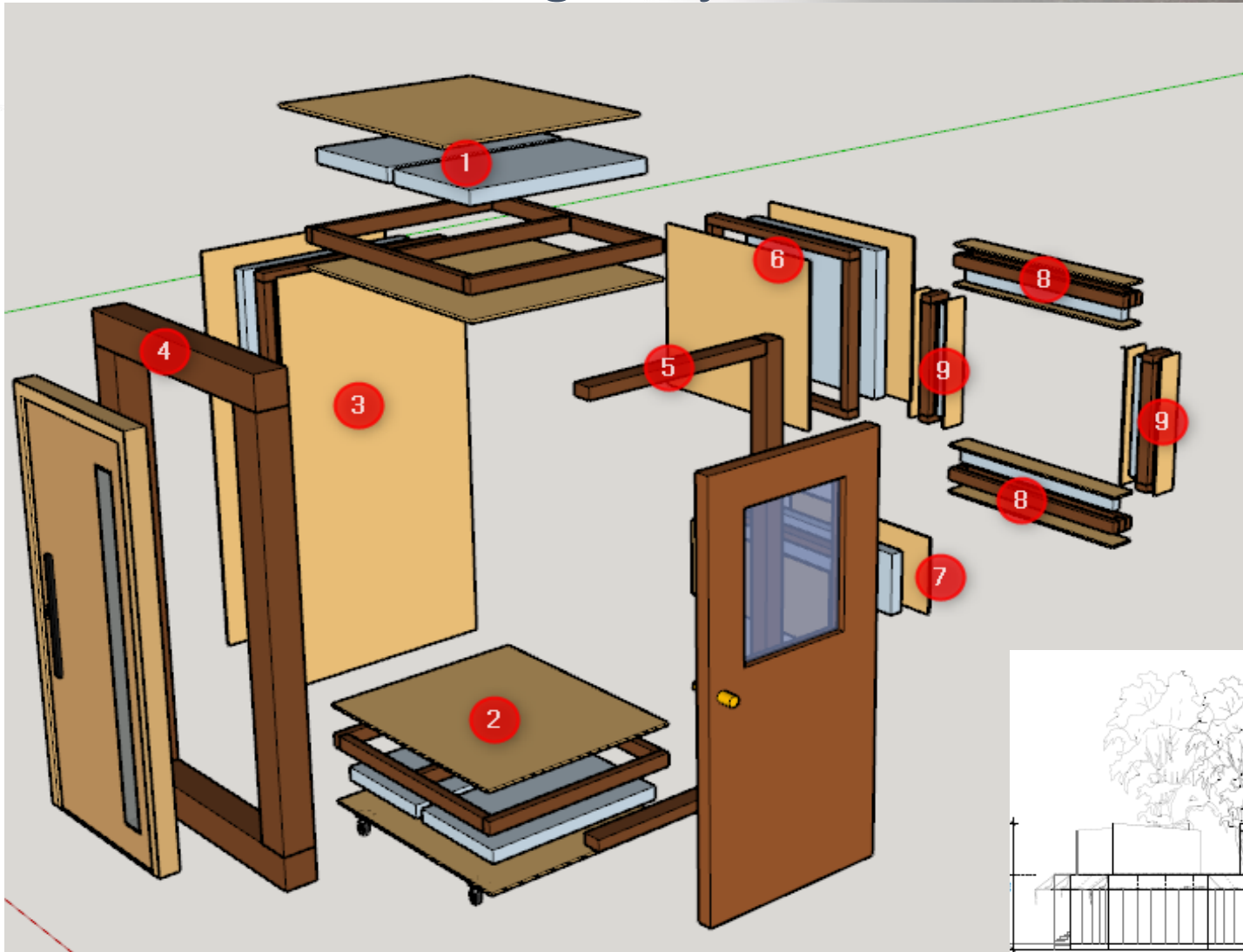

Daljnje aktivnosti

KONFERENCIJA
“DRVO U GRADITELJSTVU”

Stanje

- Primjena DuG se savršeno uklapa u sve strateške dokumente EU
- Dostupna sirovina, poluproizvodi i drvo na postojećim objektima predstavljaju veliki potencijal

Mogućnosti

- Razvoj / izrada proizvoda visoke dodane vrijednosti / spremnih za uporabu
- Razvoj / izrada novih materijala / proizvoda za drvnu gradnju

Potrebe

- Usklađivanje ideja / razvojnih projekata s mogućnostima i potrebama poduzetnika
- Organizacija i opremanje tehničkog instituta za razvoj proizvoda od drva
- Okupljanje interdisciplinarnog tima u TID-u

KONFERENCIJA
“DRVO U GRADITELJSTVU”

HVALA
NA PAŽNJI!



REPUBLIKA HRVATSKA
Ministarstvo prostornoga uređenja,
graditeljstva i državne imovine



HUP
Hrvatska udruza profesionalaca

oris
KUĆArhitekture
HOUSE OF ARCHITECTURE

